

# QUICK COUPLINGS

SWING COUPLING / SV SERIE / STAINLESS STEEL SERIE



SMART SOLUTIONS FOR INDUSTRIAL CONNECTIONS

# Stainless Steel Series Product Overview



SV 2-Stage  
Non-Interchangeable  
**DN6**  
1/4"



SV 1-Stage  
**DN11**  
Non-interchangeable  
Heavy-Duty Range





- EN Features**
- Simple operation – minimal connection force needed
  - Compact design
  - Long service life – low maintenance
  - Sterilizable (CIP)

**Application**

Compressed air and gas supply, measurement and control systems in:

- Machine and apparatus engineering
- Medical, chemical and pharmaceutical

**Procedure**

**Connection**

Push plug into coupling until it is heard to engage by a click.

**Disconnection**

Turn release ring to the left and pull out plug.

In order to prevent the hose from ejecting dangerously, the plug must be held in the hand until the hose is completely ventilated.

- DE Auf einen Blick**
- Einfache Bedienung – geringer Kraftaufwand
  - Kompakte Bauform
  - Hohe Standzeit – wartungsarm
  - Sterilisierbar (CIP)

**Anwendungsbereich**

Druckluft- und Gasversorgung, Mess-, Steuer- und Regeltechnik, Automation in:

- Anlagenbau
- Medizinaltechnik, Chemie und Pharma

**Handhabung**

**Einkuppeln**

Stecknippel in Kupplung eindrücken bis er hörbar einrastet.

**Auskuppeln**

Auslösering nach links drehen und Stecknippel herausziehen.

Um ein gefährliches Rückschlagen zu vermeiden, muss der Stecknippel so lange in der Hand gehalten werden, bis der Schlauch vollständig entlüftet ist.

- FR En bref**
- Maniement simple et sans effort
  - Forme compacte
  - Durée de vie élevée – entretien minime
  - Stérilisable (CIP)

**Domaine d'application**

Alimentation en gaz et en air comprimé, équipement de mesure, de pilotage, de réglage et d'automatisme par ex.:

- moyens de production
- technique médicale, chimie et pharmacie

**Manipulation**

**Accouplement**

Introduire l'about de raccordement dans le coupleur jusqu'au dé clic audible.

**Désaccouplement**

Tourner la bague de déclenchement vers la gauche et puis désengager l'about de raccordement.

Pour éviter un coup de fouet du tuyau, il convient de garder l'about en main jusqu'à ce que le tuyau soit entièrement purgé.

- NL In een oogopslag**
- Eenvoudig en zonder moeite te bedienen
  - Compact ontwerp
  - Duurzaam – onderhoudsarm
  - Steriliseerbaar (CIP)

**Toepassingsgebied**

Perslucht- en gasvoorzieningen, meet- en regelsystemen:

- Installatiebouw
- Medische techniek, chemie en farmacie

**Gebruik**

**Koppelen**

Druk de insteeknippel in de koppeling totdat er hoorbaar een verbinding wordt gemaakt.

**Ontkoppelen**

Draai de ontkoppelingsring naar links en trek de insteeknippel los.

Om een gevaarlijke loskoppeling van de slang te voorkomen, moet de insteeknippel met de hand vast worden gehouden totdat de slang volledig is ontlucht.

Operating Pressure	Betriebsdruck	Pression de service	Werkdruk
<ul style="list-style-type: none"> <li>Up to 25 bar, Vacuum till 100 mbar</li> <li>connection/disconnection to max. 15 bar</li> </ul>	<ul style="list-style-type: none"> <li>Bis 25 bar, techn. Vakuum bis 100 mbar</li> <li>ein-/auskuppeln bis max. 15 bar</li> </ul>	<ul style="list-style-type: none"> <li>Jusqu'à 25 bar, Vide technique jusqu'à 100 mbar</li> <li>accouplement/désaccouplement jusqu'à 15 bar max</li> </ul>	<ul style="list-style-type: none"> <li>tot 25 bar, 100 mbar Vacuüm</li> <li>aan- en afkoppelen tot max. 15 bar</li> </ul>

**Options**

- FFKM FDA EPDM STEEL

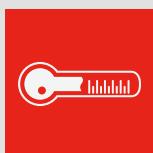

-20° to + 200°C (FPM)  
+5° to + 392°F

**Plug Profile**

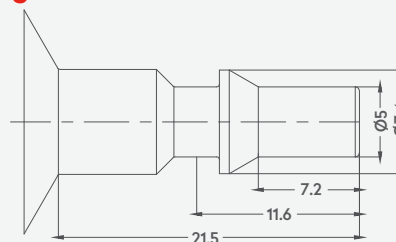

**Compatible with**

TST 107.03



# SV 1 - Stage DN3 1/8"



## QUICK ACTION COUPLING SCHNELLVERSCHLUSS-KUPPLUNG

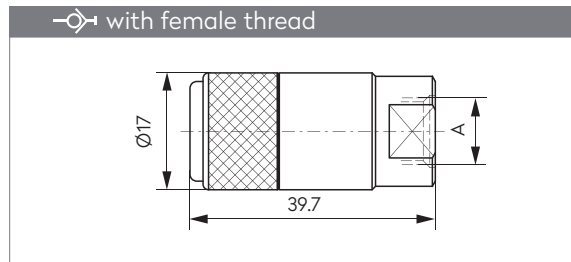

A	Stainless Steel
G1/8	303 00 580
NPT1/8	303 00 581

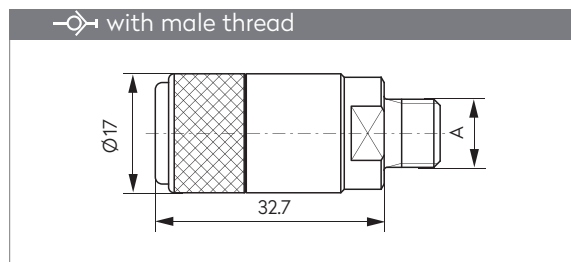

A	Stainless Steel
G1/8	303 00 582
NPT1/8	303 00 584
G1/4	303 00 583

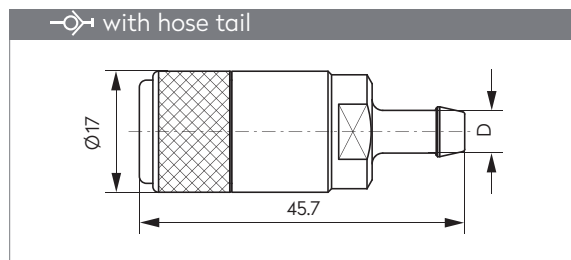

D	Stainless Steel
4 mm 3/16"	303 00 585
6 mm 1/4"	303 00 586
8 mm 5/16"	303 00 587

## PLUG STECKNIPPEL

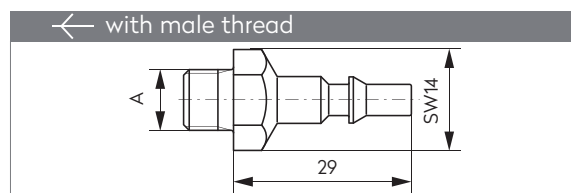

A	Stainless Steel
G1/8	355 00 274
NPT1/8	355 00 338

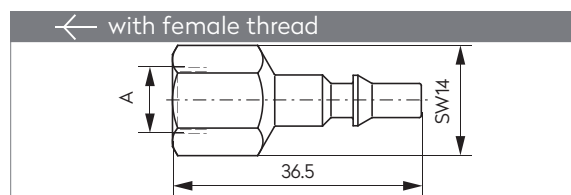

A	Stainless Steel
G1/8	355 00 273
NPT1/8	355 00 339

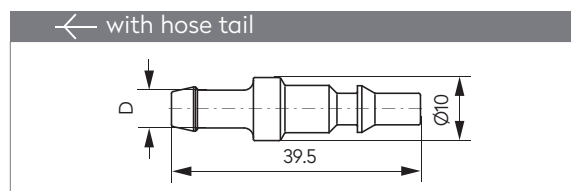

D	Stainless Steel
4 mm 3/16"	355 00 276
6 mm 1/4"	355 00 277



# SV 2-Stage

# DN6

# 1/4"

ISO 4414 EN 983  
ISO 6150-C-10



- EN Features**
- 2-stage disconnection
  - Simple operation – minimal connection force needed
  - Long service life – low maintenance
  - Sterilizable (CIP)

### Application

Compressed air and gas supply, measurement and control systems in:

- Machine and apparatus engineering
- Medical, chemical and pharmaceutical
- Food- and beverage industry

### Procedure

#### Connection

Push plug into coupling until it is heard to engage by a click.

#### Disconnection

The plug is disconnected by turning the release ring to the left. It is held back by the safety catch, until the hose is ventilated. The plug can only be released by turning the release ring to the right.

- DE Auf einen Blick**
- 2-Stufen-Entkupplung
  - Einfache Bedienung – geringer Kraftaufwand
  - Hohe Standzeit – wartungsarm
  - Sterilisierbar (CIP)

### Anwendungsbereich

Druckluft- und Gasversorgung, Mess-, Steuer- und Regeltechnik in:

- Anlagenbau
- Medizinaltechnik, Chemie und Pharma
- Nahrungsmittel- und Getränkeindustrie

### Handhabung

#### Einkuppeln

Stecknippel in Kupplung eindrücken bis er hörbar einrastet.

#### Auskuppeln

Durch Linksdrehung des Auslöserings wird der Stecknippel ausgekuppelt, jedoch von der Sicherheitsklinke zurückgehalten, bis der Schlauch entlüftet ist. Erst nach Rechtsdrehung des Auslöserings wird der Stecknippel freigegeben.

- FR En bref**
- Désaccouplement en 2 temps Forme compacte
  - Maniement simple et sans effort
  - Durée de vie élevée – entretien minime
  - Stérilisable (CIP)

### Domaine d'application

Alimentation en gaz et en air comprimé, équipement de mesure, de pilotage, de réglage et d'automatisme par ex.:

- moyens de production
- technique médicale, chimie et pharmacie
- Industrie alimentaire et des boissons

### Manipulation

#### Accouplement

Introduire l'about de raccordement dans le coupleur jusqu'au déclic audible.

#### Désaccouplement

Un mouvement à gauche de la bague de déclenchement dégage l'about de raccordement retenu par le cliquet de sécurité jusqu'à ce que le tuyau soit purgé. En tournant la bague de déclenchement vers la droite l'about de raccordement sera entièrement délogé.

- NL In een oogopslag**
- 2-staps ontkoppeling
  - Eenvoudig en zonder moeite te bedienen
  - Duurzaam – onderhoudsarm
  - Steriliseerbaar (CIP)

### Toepassingsgebied

Perslucht- en gasvoorzieningen, meet- en regelsystemen:

- Installatiebouw
- Medische techniek, chemie en farmacie
- Voedsel- en drankenindustrie

### Gebruik

#### Koppelen

Druk de insteeknippel in de koppeling totdat er hoorbaar een verbinding wordt gemaakt.

#### Ontkoppelen

De insteeknippel kan worden losgekoppeld door de ontkoppelingsring naar links te draaien. De insteeknippel wordt door de borggrendel tegengehouden, totdat de slang is ontluicht. De insteeknippel kan alleen worden ontkoppeld door de ontkoppelingsring naar rechts te draaien.

Operating Pressure	Betriebsdruck	Pression de service	Werkdruk
<ul style="list-style-type: none"> <li>Up to 25 bar, Vacuum till 100 mbar</li> <li>connection/disconnection to max. 15 bar</li> </ul>	<ul style="list-style-type: none"> <li>Bis 25 bar, techn. Vakuum bis 100 mbar</li> <li>ein-/auskuppeln bis max. 15 bar</li> </ul>	<ul style="list-style-type: none"> <li>Jusqu'à 25 bar, Vide technique jusqu'à 100 mbar</li> <li>accouplement/désaccouplement jusqu'à 15 bar max</li> </ul>	<ul style="list-style-type: none"> <li>tot 25 bar, 100 mbar Vacuüm</li> <li>aan- en afkoppelen tot max. 15 bar</li> </ul>

### Options

FFKM FDA EPDM STEEL

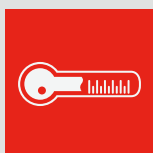

-20° to + 200°C (FPM)  
+5° to + 392°F

### Plug Profile K

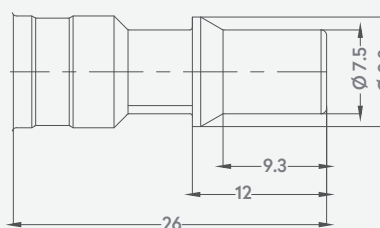

### Compatible with

TST 107.06  
Swing Coupling Serie K



**tst**<sup>®</sup>

SV 2 - Stage

**DN6**  
1/4"



**QUICK ACTION COUPLING SCHNELLVERSCHLUSS-KUPPLUNG**

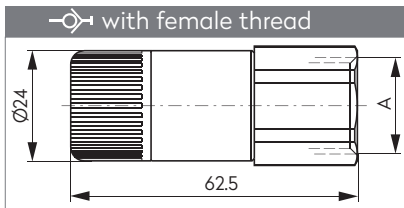

A	Stainless Steel
G1/8	303 00 588
G1/4	303 00 589
NPT1/4	303 00 599
G3/8	303 00 590
NPT3/8	303 00 600
G1/2	303 00 591

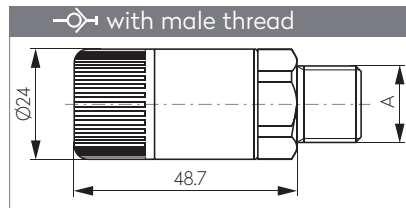

A	Stainless Steel
G1/4	303 00 592
NPT1/4	303 00 601
G3/8	303 00 593
NPT3/8	303 00 602
G1/2	303 00 594

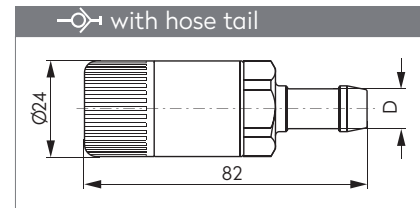

D	Stainless Steel
6 mm 1/4"	303 00 595
8 mm 5/16"	303 00 596
10 mm 3/8"	303 00 597
13 mm 1/2"	303 00 598

**PLUG STECKNIPPEL**

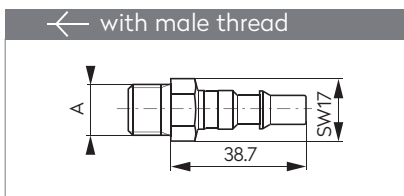

A	Stainless Steel
G1/8	355 00 125
G1/4	355 00 126
NPT1/4	355 00 129
G3/8	355 00 127
NPT3/8	355 00 130

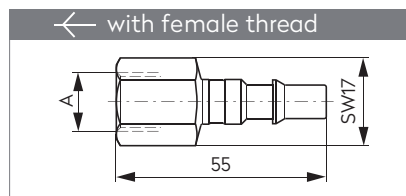

A	Stainless Steel
G1/8	355 00 123
G1/4	355 00 124
NPT1/4	355 00 208
NPT3/8	355 00 264

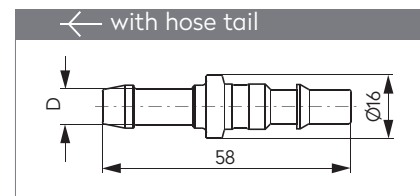

D	Stainless Steel
6 mm 1/4"	355 00 102
8 mm 5/16"	355 00 103
10 mm 3/8"	355 00 104
13 mm 1/2"	355 00 105

**PLUG WITH CHECK VALVE VERSCHLUSSNIPPEL**

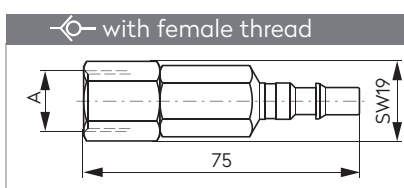

A	Stainless Steel
G1/4	353 00 117
NPT1/4	353 00 309
G3/8	353 00 118
NPT3/8	353 00 310

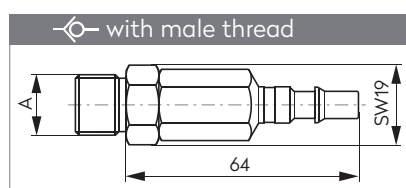

A	Stainless Steel
G1/4	353 00 119
NPT1/4	353 00 311
G3/8	353 00 120
NPT3/8	353 00 312

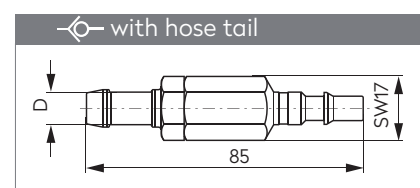

D	Stainless Steel
6 mm 1/4"	353 00 121
8 mm 5/16"	353 00 122
10 mm 3/8"	353 00 123
13 mm 1/2"	353 00 313



# SV 2-Stage

# DN8

# 3/8"

ISO 4414 EN 983

ISO 6150-C-14



**EN Features**

- 2-stage disconnection
- Simple operation – minimal connection force needed
- Long service life – low maintenance
- Sterilizable (CIP)

**Application**  
Compressed air and gas supply, measurement and control systems in:

- Machine and apparatus engineering
- Medical, chemical and pharmaceutical
- Food- and beverage industry

**Procedure Connection**  
Push plug into coupling until it is heard to engage by a click.

**Disconnection**  
The plug is disconnected by turning the release ring to the left. It is held back by the safety catch, until the hose is ventilated. The plug can only be released by turning the release ring to the right.

**DE Auf einen Blick**

- 2-Stufen-Entkupplung
- Einfache Bedienung – geringer Kraftaufwand
- Hohe Standzeit – wartungsarm
- Sterilisierbar (CIP)

**Anwendungsbereich**  
Druckluft- und Gasversorgung, Mess-, Steuer- und Regeltechnik in:

- Anlagenbau
- Medizinaltechnik, Chemie und Pharma
- Nahrungsmittel- und Getränkeindustrie

**Handhabung Einkuppeln**  
Stecknippel in Kupplung eindrücken bis er hörbar einrastet.

**Auskuppeln**  
Durch Linksdrehung des Auslöserings wird der Stecknippel ausgekuppelt, jedoch von der Sicherheitsklinke zurückgehalten, bis der Schlauch entlüftet ist. Erst nach Rechtsdrehung des Auslöserings wird der Stecknippel freigegeben.

**FR En bref**

- Désaccouplement en 2 temps Forme compacte
- Maniement simple et sans effort
- Durée de vie élevée – entretien minime
- Stérilisable (CIP)

**Domaine d'application**  
Alimentation en gaz et en air comprimé, équipement de mesure, de pilotage, de réglage et d'automatisme par ex.:

- Moyens de production
- Technique médicale, chimie et pharmacie
- Industrie alimentaire et des boissons

**Manipulation Accouplement**  
Introduire l'about de raccordement dans le coupleur jusqu'au déclic audible.

**Désaccouplement**  
Un mouvement à gauche de la bague de déclenchement dégage l'about de raccordement retenu par le cliquet de sécurité jusqu'à ce que le tuyau soit purgé. En tournant la bague de déclenchement vers la droite l'about de raccordement sera entièrement délogé.

**NL In een oogopslag**

- 2-staps ontkoppeling
- Eenvoudig en zonder moeite te bedienen
- Duurzaam - onderhoudsarm
- Steriliseerbaar (CIP)

**Toepassingsgebied**  
Perslucht- en gasvoorzieningen, meet- en regelsystemen:

- Installatiebouw
- Medische techniek, chemie en farmacie
- Voedsel- en drankenindustrie

**Gebruik Koppelen**  
Druk de insteeknippel in de koppeling totdat er hoorbaar een verbinding wordt gemaakt.

**Ontkoppelen**  
De insteeknippel kan worden losgekoppeld door de ontkoppelingring naar links te draaien. De insteeknippel wordt door de borggrendel tegengehouden, totdat de slang is ontluft. De insteeknippel kan alleen worden ontkoppeld door de ontkoppelingring naar rechts te draaien.

Operating Pressure
<ul style="list-style-type: none"> <li>Up to 25 bar, Vacuum till 100 mbar</li> <li>connection/disconnection to max. 15 bar</li> </ul>

Betriebsdruck
<ul style="list-style-type: none"> <li>Bis 25 bar, techn. Vakuum bis 100 mbar</li> <li>ein-/auskuppeln bis max. 15 bar</li> </ul>

Pression de service
<ul style="list-style-type: none"> <li>Jusqu'à 25 bar, Vide technique jusqu'à 100 mbar</li> <li>accouplement/désaccouplement jusqu'à 15 bar max</li> </ul>

Werkdruk
<ul style="list-style-type: none"> <li>tot 25 bar, 100 mbar Vacuüm</li> <li>aan- en afkoppelen tot max. 15 bar</li> </ul>

**Options**

FFKM FDA EPDM STEEL

-20° to + 200°C (FPM)  
+5° to + 392°F

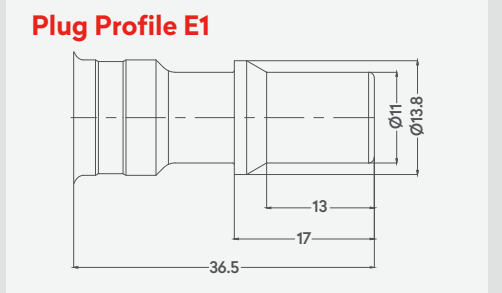

**Compatible with**  
TST 107.08  
Swing Coupling Serie E1



## QUICK ACTION COUPLING SCHNELLVERSCHLUSS-KUPPLUNG

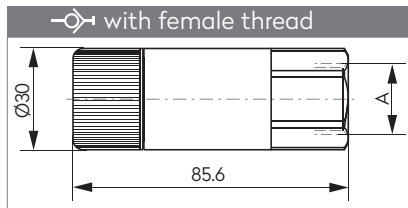

A	Stainless Steel
G1/4	303 00 300
G3/8	303 00 603
NPT3/8	303 00 605
G1/2	303 00 604
NPT1/2	303 00 606

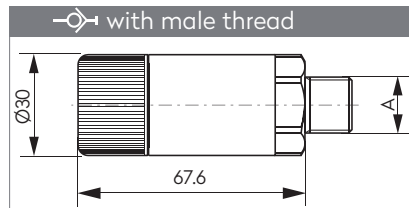

A	Stainless Steel
G3/8	303 00 607
NPT3/8	303 00 609
G1/2	303 00 608
NPT1/2	303 00 610

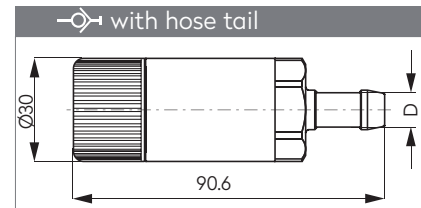

D	Stainless Steel
8 mm 5/16"	303 00 611
10 mm 3/8"	303 00 612
13 mm 1/2"	303 00 613
16 mm 5/8"	303 00 614

## PLUG STECKNIPPEL

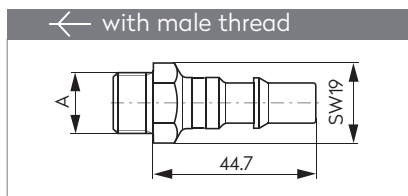

A	Stainless Steel
G1/4	355 00 090
NPT1/4	355 00 092
G3/8	355 00 091
NPT3/8	355 00 093

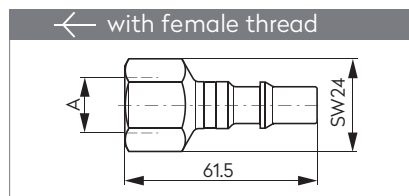

A	Stainless Steel
G1/4	355 00 088
NPT1/4	355 00 094
G3/8	355 00 089
NPT3/8	355 00 095
NPT1/2	355 00 359

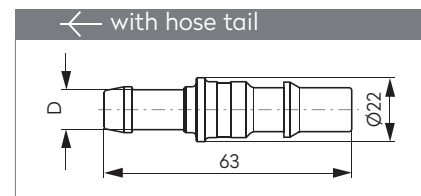

D	Stainless Steel
8 mm 5/16"	355 00 096
10 mm 3/8"	355 00 097
13 mm 1/2"	355 00 098
16 mm 5/8"	355 00 099

## PLUG WITH CHECK VALVE VERSCHLUSSNIPPEL

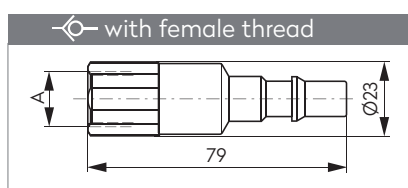

A	Stainless Steel
G3/8	353 00 100
NPT3/8	353 00 314

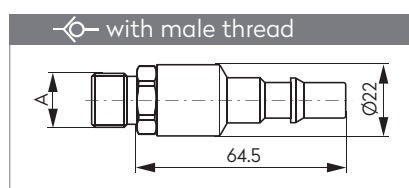

A	Stainless Steel
G3/8	353 00 102
NPT3/8	353 00 315

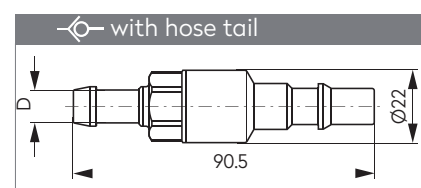

D	Stainless Steel
10 mm 3/8"	353 00 104
13 mm 1/2"	353 00 106



# tst

## SV 2-Stage

# DN11

# 1/2"

ISO 4414 EN 983

ISO 6150-C-14



- EN Features**
- 2-stage disconnection
  - Simple operation – minimal connection force needed
  - Long service life – low maintenance
  - Sterilizable (CIP)

**Application**  
Compressed air and gas supply, measurement and control systems in:

- Machine and apparatus engineering
- Medical, chemical and pharmaceutical
- Food- and beverage industry

**Procedure Connection**  
Push plug into coupling until it is heard to engage by a click.

**Disconnection**  
The plug is disconnected by turning the release ring to the left. It is held back by the safety catch, until the hose is ventilated. The plug can only be released by turning the release ring to the right.

- DE Auf einen Blick**
- 2-Stufen-Entkupplung
  - Einfache Bedienung – geringer Kraftaufwand
  - Hohe Standzeit – wartungsarm
  - Sterilisierbar (CIP)

**Anwendungsbereich**  
Druckluft- und Gasversorgung, Mess-, Steuer- und Regeltechnik in:

- Anlagenbau
- Medizinaltechnik, Chemie und Pharma
- Nahrungsmittel- und Getränkeindustrie

**Handhabung Einkuppeln**  
Stecknippel in Kupplung eindrücken bis er hörbar einrastet.

**Auskuppeln**  
Durch Linksdrehung des Auslöserings wird der Stecknippel ausgekuppelt, jedoch von der Sicherheitsklinke zurückgehalten, bis der Schlauch entlüftet ist. Erst nach Rechtsdrehung des Auslöserings wird der Stecknippel freigegeben.

- FR En bref**
- Désaccouplement en 2 temps Forme compacte
  - Maniement simple et sans effort
  - Durée de vie élevée – entretien minime
  - Stérilisable (CIP)

**Domaine d'application**  
Alimentation en gaz et en air comprimé, équipement de mesure, de pilotage, de réglage et d'automatisme par ex.:

- moyens de production
- technique médicale, chimie et pharmacie
- Industrie alimentaire et des boissons

**Manipulation Accouplement**  
Introduire l'about de raccordement dans le coupleur jusqu'au déclic audible.

**Désaccouplement**  
Un mouvement à gauche de la bague de déclenchement dégage l'about de raccordement retenu par le cliquet de sécurité jusqu'à ce que le tuyau soit purgé. En tournant la bague de déclenchement vers la droite l'about de raccordement sera entièrement délogé.

- NL In een oogopslag**
- 2-staps ontkoppeling
  - Eenvoudig en zonder moeite te bedienen
  - Duurzaam – onderhoudsarm
  - Steriliseerbaar (CIP)

**Toepassingsgebied**  
Perslucht- en gasvoorzieningen, meet- en regelsystemen:

- Installatiebouw
- Medische techniek, chemie en farmacie
- Voedsel- en drankenindustrie

**Gebruik Koppelen**  
Druk de insteeknippel in de koppeling totdat er hoorbaar een verbinding wordt gemaakt.

**Ontkoppelen**  
De insteeknippel kan worden losgekoppeld door de ontkoppelingsring naar links te draaien. De insteeknippel wordt door de borggrendel tegengehouden, totdat de slang is ontlucht. De insteeknippel kan alleen worden ontkoppeld door de ontkoppelingsring naar rechts te draaien.

**Operating Pressure**

- Up to 25 bar, Vacuum till 100 mbar
- connection/disconnection to max. 15 bar

**Betriebsdruck**

- Bis 25 bar, techn. Vakuum bis 100 mbar
- ein-/auskuppeln bis max. 15 bar

**Pression de service**

- Jusqu'à 25 bar, Vide technique jusqu'à 100 mbar
- accouplement/désaccouplement jusqu'à 15 bar max

**Werkdruk**

- tot 25 bar, 100 mbar Vacuüm
- aan- en afkoppelen tot max. 15 bar

- Options**
- FFKM
  - FDA
  - EPDM
  - STEEL

-20° to + 200°C (FPM)  
+5° to + 392°F

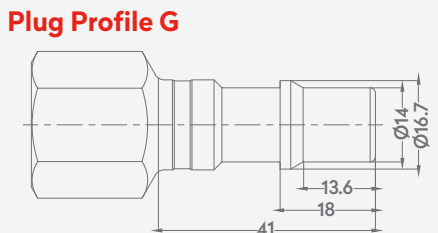

**Compatible with**  
TST 107.11  
Swing Coupling Serie G

# SV 2 - Stage

# DN11

1/2"



## QUICK ACTION COUPLING SCHNELLVERSCHLUSS-KUPPLUNG

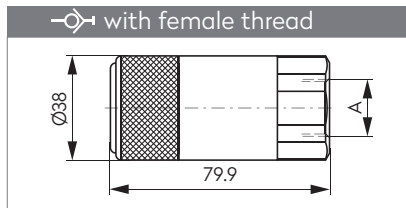

A	Stainless Steel
G3/8	303 00 615
NPT3/8	303 00 618
G1/2	303 00 616
NPT1/2	303 00 619
G3/4	303 00 617
NPT3/4	303 00 620

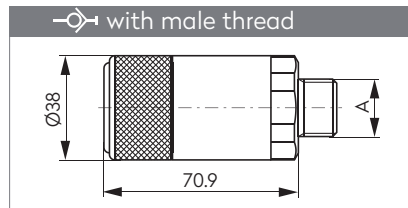

A	Stainless Steel
G3/8	303 00 621
NPT3/8	303 00 625
G1/2	303 00 622
NPT1/2	303 00 626
G3/4	303 00 623
NPT3/4	303 00 627
G1	303 00 624

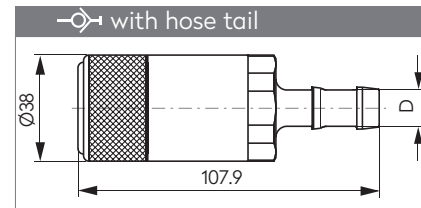

D	Stainless Steel
13 mm 1/2"	303 00 628
16 mm 5/8"	303 00 154
19 mm 3/4"	303 00 156

## PLUG STECKNIPPEL

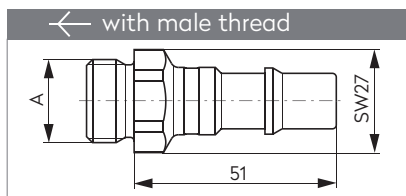

A	Stainless Steel
G3/8	355 00 110
G1/2	355 00 111
NPT1/2	355 00 117
G3/4	355 00 112
NPT3/4	355 00 118

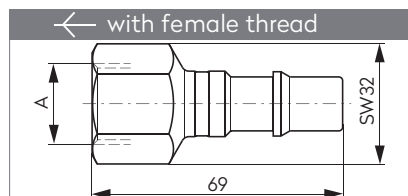

A	Stainless Steel
G3/8	355 00 107
NPT3/8	355 00 113
G1/2	355 00 108
NPT1/2	355 00 114
G3/4	355 00 109
NPT 3/4	355 00 115

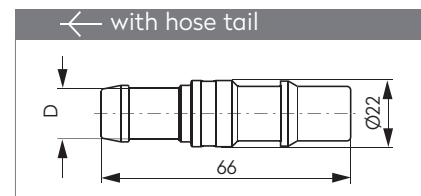

D	Stainless Steel
10 mm 3/8"	355 00 119
13 mm 1/2"	355 00 120
16 mm 5/8"	355 00 121
19 mm 3/4"	355 00 122

## PLUG WITH CHECK VALVE VERSCHLUSSNIPPEL

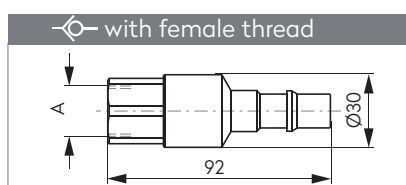

A	Stainless Steel
G3/8	353 00 316
NPT3/8	353 00 318
G1/2	353 00 317
NPT1/2	353 00 319

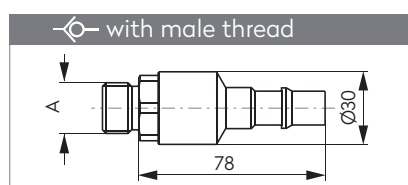

A	Stainless Steel
G3/8	353 00 320
NPT3/8	353 00 322
G1/2	353 00 268
NPT1/2	353 00 323
G3/4	353 00 321

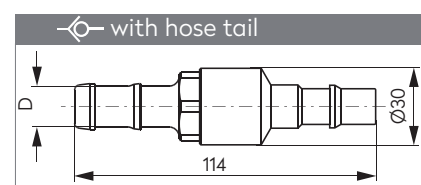

D	Stainless Steel
13 mm 1/2"	353 00 324
16 mm 5/8"	353 00 147
19 mm 3/4"	353 00 222



**EN**

### Features

- 2-stage disconnection
- Extremely robust design
- Long service life – low maintenance

### Application

Compressed air and gas supply in extremely rough working conditions in:

- Marine and ship-building
- Petrochemical (oil and gas industries)

### Procedure

#### Connection

Push plug into coupling and turn it to the right until the mechanism is heard to engage by a click.

#### Disconnection

Turn plug to the left while simultaneously gently pulling back the release ring. The plug is withheld from ejecting by the safety chamber and can only be released by another 90° turn to the left or to the right.

**DE**

### Auf einen Blick

- 2-Stufen-Entkupplung
- Extrem robuste Ausführung
- Hohe Standzeit – wartungsarm

### Anwendungsbereich

Druckluft und Gasversorgung in extrem rauen Bedingungen in:

- Marine und Schiffsbau
- Raffinerien (Öl- und Gasindustrie)

### Handhabung

#### Einkuppeln

Stecknippel in Kupplung einführen, nach rechts drehen bis der Mechanismus hörbar einrastet.

#### Auskuppeln

Stecknippel nach links drehen und gleichzeitig Auslösering leicht nach hinten ziehen. Der Stecknippel wird beim Ausstoss von der Sicherheitskammer aufgefangen und erst nach einer weiteren Links- oder Rechtsdrehung um 90° freigegeben.

**FR**

### En bref

- Désaccouplement en 2 temps Forme compacte
- Modèle extrêmement robuste
- Durée de vie élevée – entretien minime

### Domaine d'application

Alimentation en gaz et en air comprimé pour des conditions extrêmement rudes, par ex.:

- Marine et construction navale
- Raffineries (industrie du pétrole et du gaz)

### Manipulation

#### Accouplement

Introduire l'about de raccordement dans le coupleur et le tourner vers la droite jusqu'au dé clic audible du mécanisme.

#### Désaccouplement

Tourner l'about de raccordement vers la gauche et en même temps tirer la bague de déclenchement légèrement vers l'arrière. L'about de raccordement est toutefois retenu dans la chambre de sécurité et seulement libéré après une rotation de 90° vers la gauche ou vers la droite.

**NL**

### In een oogopslag

- 2-staps ontkoppeling
- Zeer robuust ontwerp
- Duurzaam – onderhoudsarm

### Toepassingsgebied

Perslucht- en gasvoorzieningen, bij extreme werkomstandigheden:

- Marine en scheepsbouw
- Raffinaderijen (olie- en gasindustrie)

### Gebruik

#### Koppelen

Duw de insteeknippel in de koppeling en draai deze naar rechts, totdat er hoorbaar een verbinding wordt gemaakt.

#### Ontkoppelen

De insteeknippel kan worden ontkoppeld door de ontkoppelingring naar links te draaien. Het wordt door de borgkamer tegengehouden en kan alleen worden ontkoppeld door de nogmaals 90 graden naar links- of rechts te draaien.

 Operating Pressure
<ul style="list-style-type: none"> <li>• Up to 25 bar, Vacuum till 100 mbar</li> <li>• connection/disconnection to max. 15 bar</li> </ul>

 Betriebsdruck
<ul style="list-style-type: none"> <li>• Bis 25 bar, techn. Vakuum bis 100 mbar</li> <li>• ein-/auskuppeln bis max. 15 bar</li> </ul>

 Pression de service
<ul style="list-style-type: none"> <li>• Jusqu'à 25 bar, Vide technique jusqu'à 100 mbar</li> <li>• accouplement/désaccouplement jusqu'à 15 bar max</li> </ul>

 Werkdruk
<ul style="list-style-type: none"> <li>• tot 25 bar, 100 mbar Vacuüm</li> <li>• aan- en afkoppelen tot max. 15 bar</li> </ul>

### Options

<b>FFKM</b>	<b>FDA</b>	<b>EPDM</b>	<b>STEEL</b>
-------------	------------	-------------	--------------

 -20° to + 200°C (FPM)  
+5° to + 392°F

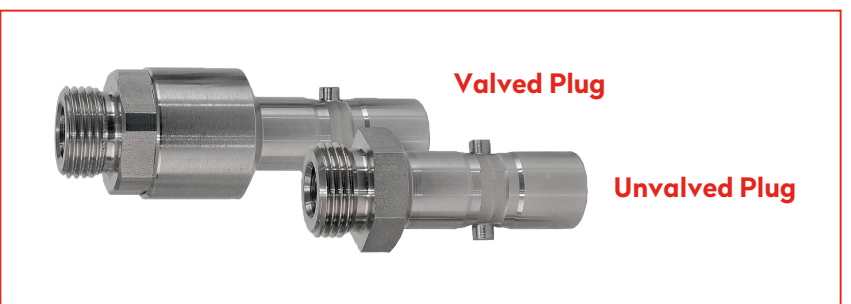



## QUICK ACTION COUPLING SCHNELLVERSCHLUSS-KUPPLUNG

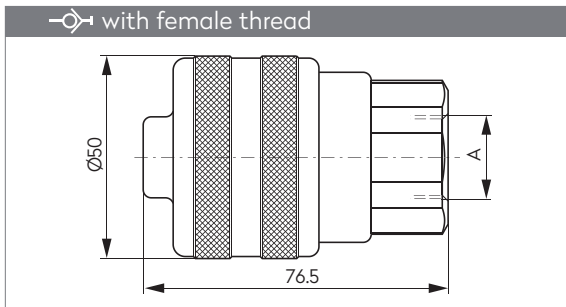

A	Stainless Steel
G3/8	303 00 629
NPT3/8	303 00 631
G1/2	303 00 206
NPT1/2	303 00 632
G3/4	303 00 630
NPT3/4	303 00 633

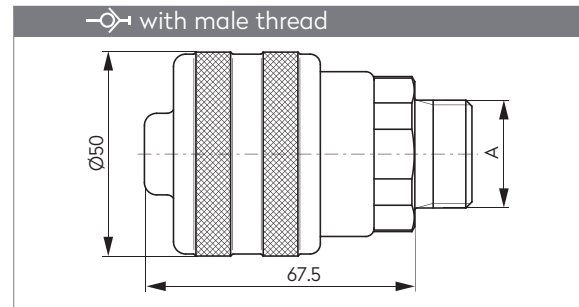

A	Stainless Steel
G3/8	303 00 634
NPT3/8	303 00 638
G1/2	303 00 635
NPT1/2	303 00 639
G3/4	303 00 636
NPT3/4	303 00 640
G1	303 00 637

## PLUG STECKNIPPEL

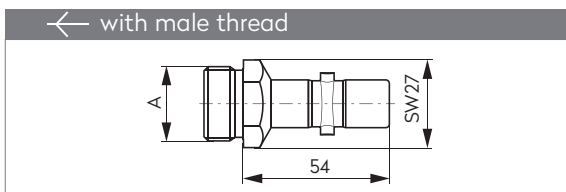

A	Stainless Steel
G3/8	355 00 135
G1/2	355 00 136
NPT1/2	355 00 285
G3/4	355 00 137
NPT3/4	355 00 340

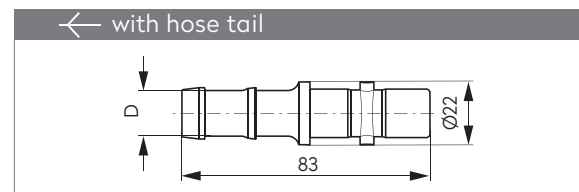

D	Stainless Steel
10 mm 3/8"	355 00 131
13 mm 1/2"	355 00 132
16 mm 5/8"	355 00 133
19 mm 3/4"	355 00 134

## PLUG WITH CHECK VALVE VERSCHLUSSNIPPEL

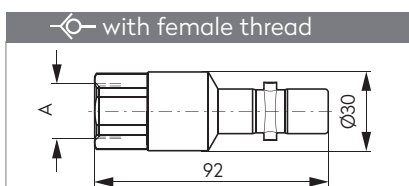

A	Stainless Steel
G3/8	353 00 226
NPT3/8	353 00 325
G1/2	353 00 015
NPT1/2	353 00 326

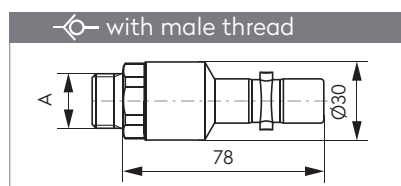

A	Stainless Steel
G3/8	353 00 327
NPT3/8	353 00 330
G1/2	353 00 328
NPT1/2	353 00 331
G3/4	353 00 329

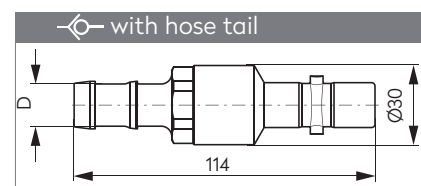

D	Stainless Steel
13 mm 1/2"	353 00 332
16 mm 5/8"	353 00 333
19 mm 3/4"	353 00 273



**EN**

### Features

- 2-stage disconnection
- Extremely robust design
- Long service life – low maintenance

### Application

Compressed air and gas supply in extremely rough working conditions in:

- Marine and ship-building
- Petrochemical (oil and gas industries)

### Procedure

#### Connection

Push plug into coupling and turn it to the right until the mechanism is heard to engage by a click.

#### Disconnection

Turn plug to the left while simultaneously gently pulling back the release ring. The plug is withheld from ejecting by the safety chamber and can only be released by another 90° turn to the left or to the right.

**DE**

### Auf einen Blick

- 2-Stufen-Entkupplung
- Extrem robuste Ausführung
- Hohe Standzeit – wartungsarm

### Anwendungsbereich

Druckluft und Gasversorgung in extrem rauen Bedingungen in:

- Marine und Schiffsbau
- Raffinerien (Öl- und Gasindustrie)

### Handhabung

#### Einkuppeln

Stecknippel in Kupplung einführen, nach rechts drehen bis der Mechanismus hörbar einrastet.

#### Auskuppeln

Stecknippel nach links drehen und gleichzeitig Auslösering leicht nach hinten ziehen. Der Stecknippel wird beim Ausstoss von der Sicherheitskammer aufgefangen und erst nach einer weiteren Links- oder Rechtsdrehung um 90° freigegeben.

**FR**

### En bref

- Désaccouplement en 2 temps Forme compacte
- Modèle extrêmement robuste
- Durée de vie élevée – entretien minime

### Domaine d'application

Alimentation en gaz et en air comprimé pour des conditions extrêmement rudes, par ex.:

- Marine et construction navale
- Raffineries (industrie du pétrole et du gaz)

### Manipulation

#### Accouplement

Introduire l'about de raccordement dans le coupleur et le tourner vers la droite jusqu'au déclic audible du mécanisme.

#### Désaccouplement

Tourner l'about de raccordement vers la gauche et en même temps tirer la bague de déclenchement légèrement vers l'arrière. L'about de raccordement est toutefois retenu dans la chambre de sécurité et seulement libéré après une rotation de 90° vers la gauche ou vers la droite.

**NL**

### In een oogopslag

- 2-staps ontkoppeling
- Zeer robuust ontwerp
- Duurzaam – onderhoudsarm

### Toepassingsgebied

Perslucht- en gasvoorzieningen, bij extreme werkomstandigheden:

- Marine en scheepsbouw
- Raffinaderijen (olie- en gasindustrie)

### Gebruik

#### Koppelen

Duw de insteeknippel in de koppeling en draai deze naar rechts, totdat het mechanisme hoorbaar een verbinding maakt.

#### Ontkoppelen

De insteeknippel kan worden ontkoppeld door de ontkoppelingsring naar links te draaien. Het wordt door de borgkamer tegengehouden en kan alleen worden ontkoppeld door de nogmaals 90 graden naar links- of rechts te draaien.

Operating Pressure	Betriebsdruck	Pression de service	Werkdruk
<ul style="list-style-type: none"> <li>Up to 25 bar, Vacuum till 100 mbar</li> <li>connection/disconnection to max. 15 bar</li> </ul>	<ul style="list-style-type: none"> <li>Bis 25 bar, techn. Vakuum bis 100 mbar</li> <li>ein-/auskuppeln bis max. 15 bar</li> </ul>	<ul style="list-style-type: none"> <li>Jusqu'à 25 bar, Vide technique jusqu'à 100 mbar</li> <li>accouplement/désaccouplement jusqu'à 15 bar max</li> </ul>	<ul style="list-style-type: none"> <li>tot 25 bar, 100 mbar Vacuüm</li> <li>aan- en afkoppelen tot max. 15 bar</li> </ul>

**Options**

FFKM FDA EPDM STEEL

-20° to + 200°C (FPM)  
+5° to + 392°F

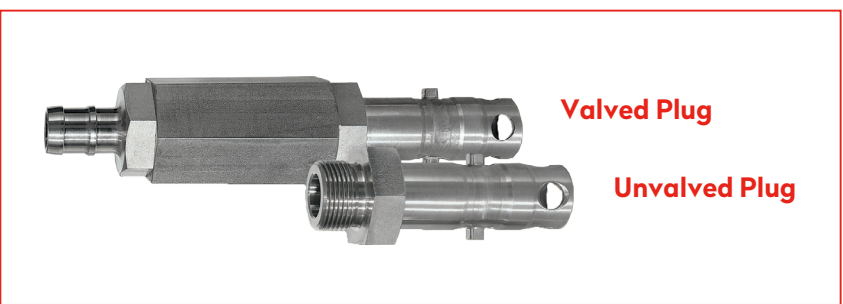



## QUICK ACTION COUPLING SCHNELLVERSCHLUSS-KUPPLUNG

↻ with female thread

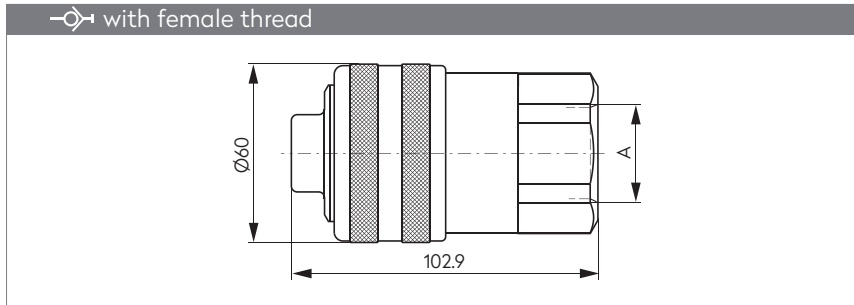

A	Stainless Steel
G3/4	303 00 641
NPT3/4	303 00 643
G1	303 00 642
NPT1	303 00 644

## PLUG STECKNIPPEL

← with male thread

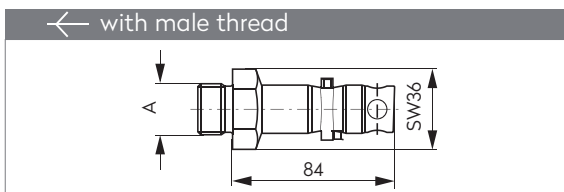

A	Stainless Steel
G3/4	355 00 279
NPT3/4	355 00 341
G1	355 00 280
NPT1	355 00 342

← with hose tail

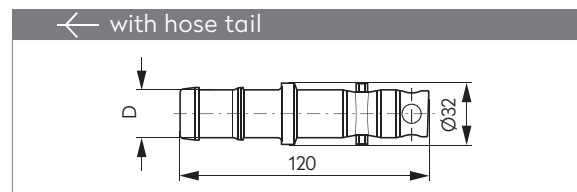

D	Stainless Steel
19 mm 3/4"	355 00 281
25 mm 1"	355 00 282

## PLUG WITH CHECK VALVE VERSCHLUSSNIPPEL

↻ with hose tail

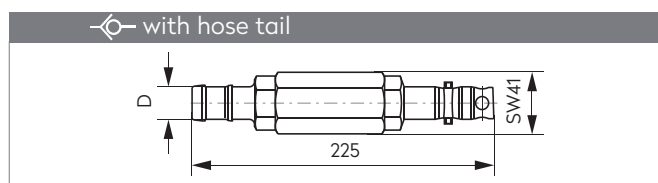

D	Stainless Steel
19 mm 3/4"	353 00 219
25 mm 1"	353 00 218



**EN**

**Features**

- Mixing of different media is impossible, as connection is only possible with plug with identical key profile
- 2-stage disconnection
- Eliminates danger of wrong line connection

**Application**

For safety-related applications, toxic media in:

- Machine and apparatus engineering
- Medical, chemical and pharmaceutical

**Procedure**

**Connection**

Push plug into coupling with matching key profile until it is heard to engage by a click.

**Disconnection**

The plug is disconnected by turning the release ring to the left. It is held back by the safety clutch, until the hose is ventilated. The plug can only be released by turning the release ring to the right.

**DE**

**Auf einen Blick**

- Verwechslung verschiedener Medien ausgeschlossen, da nur mit Stecknippel mit gleichem Schlüssel zu betätigen
- 2-Stufen Entkupplung
- Einsatz bei Verwechslungsgefahr

**Anwendungsbereich**

Für sicherheitsrelevante Anwendungen, toxische Medien in:

- Anlagenbau
- Medizinaltechnik, Chemie und Pharma

**Handhabung**

**Einkuppeln**

Stecknippel mit gleichem geometrischem Schlüssel in entsprechende Kupplung eindrücken bis er hörbar einrastet.

**Auskuppeln**

Durch Linksdrehung des Auslöserings wird der Stecknippel ausgekuppelt, jedoch von der Sicherheitsklinke zurückgehalten bis der Schlauch entlüftet ist. Erst nach Rechtsdrehung des Auslöserings wird der Stecknippel freigegeben.

**FR**

**En bref**

- Intersersion de différents fluides impossible grâce à un profil de clé identique du coupleur et de son about.
- Désaccouplement en 2 temps Forme compacte
- Application en cas de risque d'intersersion

**Domaine d'application**

Pour les applications liées à la sécurité, les fluides toxiques, par ex.:

- construction d'installations
- technique médicale, chimie et pharmacie

**Manipulation**

**Accouplement**

Introduire l'about de raccordement dont la clé est identique à celle du coupleur jusqu'au dé clic audible.

**Désaccouplement**

Un mouvement à gauche de la bague de déclenchement dégage l'about de raccordement qui cependant restera retenu par le cliquet de sécurité jusqu'à ce que le tuyau soit purgé. Ce n'est qu'en tournant la bague de déclenchement vers la droite que l'about de raccordement sera entièrement dégage.

**NL**

**In een oogopslag**

- Het samenkomen van vloeistoffen is uitgesloten, doordat er alleen verbinding kan worden gemaakt via een plug met een identiek sleutelprofiel
- 2-staps ontkoppeling
- Voorkomt verbinding met onjuiste lijn

**Toepassingsgebied**

Veiligheidsgerelateerde toepassingen, giftige vloeistoffen:

- Installatiebouw
- Medische techniek, chemie, farmacie

**Gebruik**

**Koppelen**

Druk de insteeknippel in de koppeling met het juiste sleutelprofiel, totdat er hoorbaar een verbinding wordt gemaakt.

**Ontkoppelen**

De insteeknippel kan worden ontkoppeld door de ontkoppelingsring naar links te draaien. Deze wordt door de borggrendel tegengehouden, totdat de slang is ontlucht. De insteeknippel kan alleen worden ontkoppeld door de ontkoppelingsring naar rechts te draaien.

Operating Pressure	Betriebsdruck	Pression de service	Werkdruk
<ul style="list-style-type: none"> <li>• Up to 25 bar, Vacuum till 100 mbar</li> <li>• connection/disconnection to max. 15 bar</li> </ul>	<ul style="list-style-type: none"> <li>• Bis 25 bar, techn. Vakuum bis 100 mbar</li> <li>• ein-/auskuppeln bis max. 15 bar</li> </ul>	<ul style="list-style-type: none"> <li>• Jusqu'à 25 bar, Vide technique jusqu'à 100 mbar</li> <li>• accouplement/désaccouplement jusqu'à 15 bar max</li> </ul>	<ul style="list-style-type: none"> <li>• tot 25 bar, 100 mbar Vacuüm</li> <li>• aan- en afkoppelen tot max. 15 bar</li> </ul>

**Options**

FFKM FDA EPDM STEEL

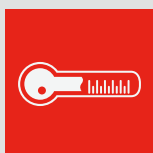

-20° to + 200°C (FPM)  
+5° to + 392°F

**Key**



Key D



Key F



Key S



Key V



tst®

SV 2 - Stage

DN 6  
1/4"



**QUICK ACTION COUPLING SCHNELLVERSCHLUSS-KUPPLUNG**

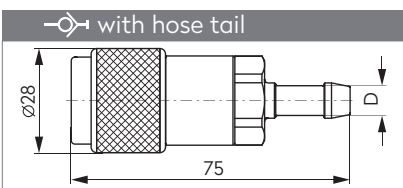
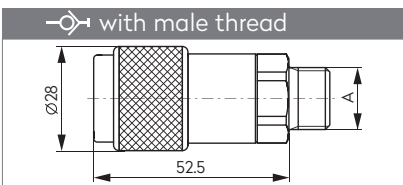
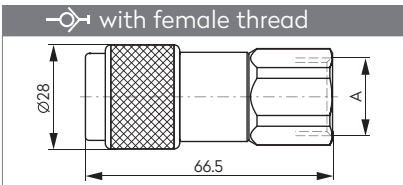

A	Key D	Key F	Key S	Key V
G1/8	303 00 645	303 00 650	303 00 655	303 00 660
G1/4	303 00 388	303 00 372	303 00 396	303 00 380
NPT1/4	303 00 487	303 00 489	303 00 491	303 00 493
G3/8	303 00 389	303 00 373	303 00 397	303 00 381
NPT3/8	303 00 646	303 00 651	303 00 656	303 00 661
G1/2	303 00 390	303 00 374	303 00 398	303 00 382

A	Key D	Key F	Key S	Key V
G1/4	303 00 391	303 00 375	303 00 399	303 00 383
NPT1/4	303 00 488	303 00 490	303 00 492	303 00 494
G3/8	303 00 392	303 00 376	303 00 400	303 00 384
NPT3/8	303 00 648	303 00 653	303 00 658	303 00 663
G1/2	303 00 647	303 00 652	303 00 657	303 00 662

A	Key D	Key F	Key S	Key V
6 mm 1/4"	303 00 393	303 00 377	303 00 401	303 00 385
8 mm 5/16"	303 00 394	303 00 378	303 00 402	303 00 386
10mm 3/8"	303 00 395	303 00 379	303 00 403	303 00 387
13mm 1/2"	303 00 649	303 00 654	303 00 659	303 00 664

**PLUG STECKNIPPEL**

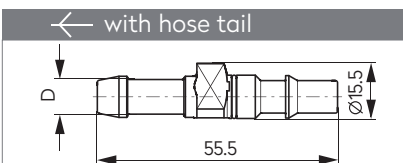
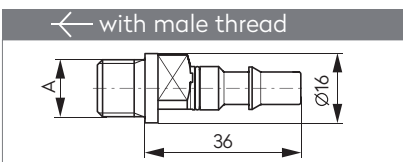

A	Key D	Key F	Key S	Key V
G1/8	355 00 296	355 00 286	355 00 306	355 00 291
G1/4	355 00 297	355 00 287	355 00 307	355 00 292
NPT1/4	355 00 343	355 00 344	355 00 345	355 00 346

A	Key D	Key F	Key S	Key V
6 mm 1/4"	355 00 298	355 00 288	355 00 308	355 00 293
8 mm 5/16"	355 00 299	355 00 289	355 00 309	355 00 294
10 mm 3/8"	355 00 300	355 00 290	355 00 310	355 00 295

**Plug with check valve**

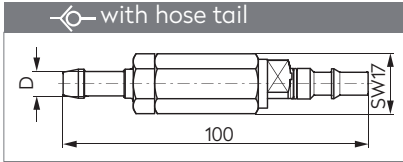
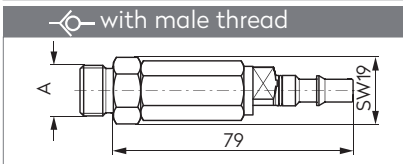
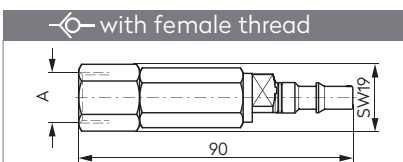

A	Key D	Key F	Key S	Key V
G1/4	353 00 253	353 00 239	353 00 260	353 00 246
NPT1/4	353 00 293	353 00 297	353 00 301	353 00 305
G3/8	353 00 254	353 00 240	353 00 261	353 00 247
NPT3/8	353 00 294	353 00 298	353 00 302	353 00 306

A	Key D	Key F	Key S	Key V
G1/4	353 00 255	353 00 241	353 00 262	353 00 248
NPT1/4	353 00 295	353 00 299	353 00 303	353 00 307
G3/8	353 00 256	353 00 242	353 00 263	353 00 249
NPT3/8	353 00 296	353 00 300	353 00 304	353 00 308

A	Key D	Key F	Key S	Key V
6 mm 1/4"	353 00 257	353 00 243	353 00 264	353 00 250
8 mm 5/16"	353 00 258	353 00 244	353 00 265	353 00 251
10 mm 3/8"	353 00 259	353 00 245	353 00 266	353 00 252





EN

### Features

- Mixing of different media is impossible as connection is only possible with plug with identical key profile
- Extremely robust design
- Eliminates danger of wrong line connection

### Application

For safety-related applications, toxic media in:

- Machine and apparatus engineering
- Petrochemical (oil and gas industries)

### Procedure

#### Connection

Push plug into coupling and turn it to the right until the mechanism is heard to engage by a click.

#### Disconnection

Turn plug to the left while simultaneously gently pulling back the release ring. In order to prevent the hose from ejecting dangerously, the plug must be held in the hand until the hose is completely ventilated.

DE

### Auf einen Blick

- Verwechslung verschiedener Medien ausgeschlossen, da nur mit Stecknippel mit gleichem Schlüssel zu betätigen
- Robuste Ausführung
- Einsatz bei Verwechslungsgefahr

### Anwendungsbereich

Für sicherheitsrelevante Anwendungen, toxische Medien in:

- Anlagenbau
- Raffinerien (Öl- und Gasindustrie)

### Handhabung

#### Einkuppeln

Stecknippel in Kupplung einführen, nach rechts drehen bis der Mechanismus hörbar einrastet.

#### Auskuppeln

Stecknippel nach links drehen und gleichzeitig den Auslösering leicht nach hinten ziehen. Um ein gefährliches Rückschlagen zu vermeiden, muss der Stecknippel so lange in der Hand gehalten werden bis der Schlauch vollständig entlüftet ist.

FR

### En bref

- Intersersion de différents fluides impossible grâce à un profil de clé identique du coupleur et de son about.
- Modèle robuste
- Application en cas de risque d'intersersion

### Domaine d'application

Pour les applications liées à la sécurité, les fluides toxiques, par ex.:

- Construction d'installations
- Raffineries (industrie du pétrole et du gaz)

### Manipulation

#### Accouplement

Introduire l'about de raccordement dans le coupleur et le tourner vers la droite jusqu'au déclic audible du mécanisme.

#### Désaccouplement

Tourner l'about de raccordement vers la gauche et en même temps tirer la bague de déclenchement légèrement vers l'arrière. Pour éviter un coup de fouet du tuyau, il convient de garder l'about en main jusqu'à ce que le tuyau soit entièrement purgé.

NL

### In een oogopslag

- Het samenkomen van vloeistoffen is uitgesloten, doordat er alleen verbinding kan worden gemaakt via een plug met een identiek profiel

- Bijzonder robuust ontwerp

- Voorkomt het risico dat er verbinding wordt gemaakt met een onjuiste lijn

### Toepassingsgebied

Veiligheidsgerelateerde toepassingen, giftige vloeistoffen:

- Installatiebouw
- Raffinaderijen (olie- en gasindustrie)

### Gebruik

#### Koppelen

Druk de insteeknippel in de koppeling en draai naar rechts totdat het mechanisme hoorbaar een koppeling maakt.

#### Ontkoppelen

Draai de insteeknippel naar links en trek gelijktijdig de ontkoppeling voorzichtig naar achteren. Om een gevaarlijke loskoppeling van de slang te vermijden, moet de insteeknippel met de hand vast worden gehouden totdat de slang volledig is ontlucht.

Operating Pressure	Betriebsdruck	Pression de service	Werkdruk
<ul style="list-style-type: none"> <li>• Up to 25 bar, Vacuum till 100 mbar</li> <li>• connection/disconnection to max. 15 bar</li> </ul>	<ul style="list-style-type: none"> <li>• Bis 25 bar, techn. Vakuum bis 100 mbar</li> <li>• ein-/auskuppeln bis max. 15 bar</li> </ul>	<ul style="list-style-type: none"> <li>• Jusqu'à 25 bar, Vide technique jusqu'à 100 mbar</li> <li>• accouplement/désaccouplement jusqu'à 15 bar max</li> </ul>	<ul style="list-style-type: none"> <li>• tot 25 bar, 100 mbar Vacuüm</li> <li>• aan- en afkoppelen tot max. 15 bar</li> </ul>

### Options

FFKM FDA EPDM STEEL



-20° to + 200°C (FPM)  
+5° to + 392°F

### Key



45°



90°



135°



# SV 1- Stage Non-interchangeable

# DN11 Keys 45°...90°...135° 1/2"



## QUICK ACTION COUPLING SCHNELLVERSCHLUSS-KUPPLUNG

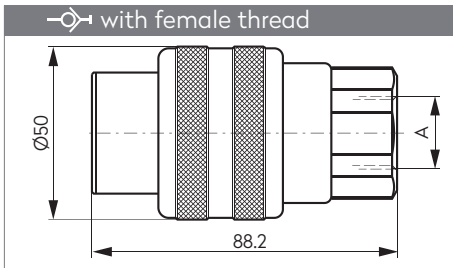

A	Key 45°	Key 90°	Key 135°
G3/8	303 00 665	303 00 670	303 00 675
G1/2	303 00 666	303 00 671	303 00 676
NPT1/2	303 00 668	303 00 673	303 00 678
G3/4	303 00 667	303 00 672	303 00 677
NPT3/4	303 00 669	303 00 674	303 00 679

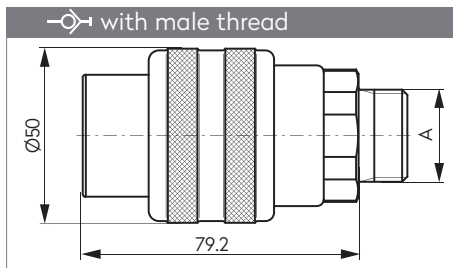

A	Key 45°	Key 90°	Key 135°
G3/8	303 00 680	303 00 686	303 00 692
NPT3/8	303 00 684	303 00 690	303 00 696
G1/2	303 00 681	303 00 687	303 00 693
NPT1/2	303 00 685	303 00 691	303 00 697
G3/4	303 00 682	303 00 688	303 00 694
G1	303 00 683	303 00 689	303 00 695

## PLUG STECKNIPPEL

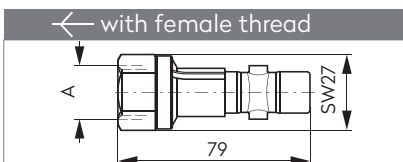

A	Key 45°	Key 90°	Key 135°
G1/2	355 00 347	355 00 351	355 00 355
NPT1/2	355 00 348	355 00 352	355 00 356

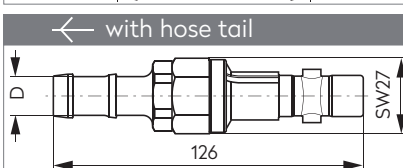

A	Key 45°	Key 90°	Key 135°
13 mm 1/2"	355 00 349	355 00 353	355 00 357
19 mm 3/4"	355 00 350	355 00 354	355 00 358

## Plug with check valve

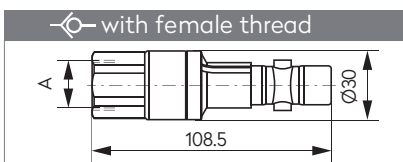

A	Key 45°	Key 90°	Key 135°
G1/2	353 00 334	353 00 341	353 00 348
NPT1/2	353 00 335	353 00 342	353 00 349

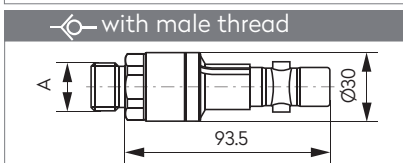

A	Key 45°	Key 90°	Key 135°
G1/2	353 00 336	353 00 343	353 00 350
NPT1/2	353 00 337	353 00 344	353 00 351
G3/4	353 00 338	353 00 345	353 00 352

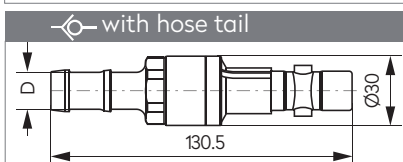

A	Key 45°	Key 90°	Key 135°
13 mm 1/2"	353 00 339	353 00 346	353 00 353
19 mm 3/4"	353 00 340	353 00 347	353 00 354

# Performance Graph Stainless Steel

Flow Rate at 68°F (20 °C)  
Operating Pressure 87 psi (6 bar)

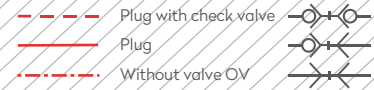

**SV 1-Stage DN3 1/8"** Performance Graph Air

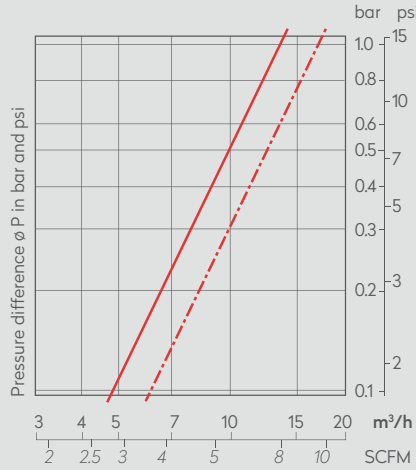

**SV 2-Stage DN6 1/4"** Performance Graph Air

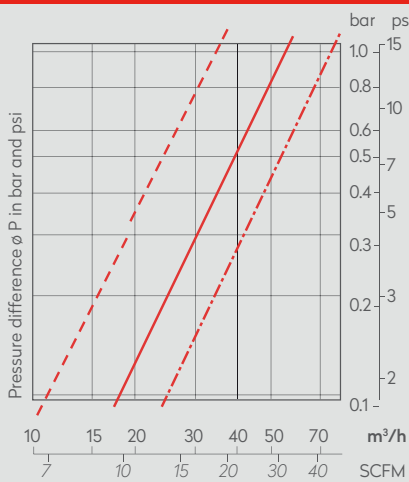

**SV 2-Stage DN6 1/4"** Performance Graph Water

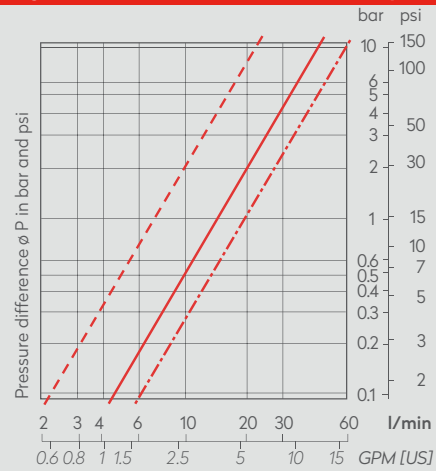

**SV 2-Stage DN8 3/8"** Performance Graph Air

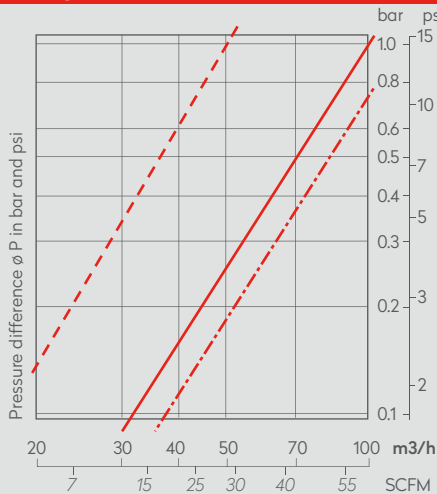

**SV 2-Stage DN8 3/8"** Performance Graph Water

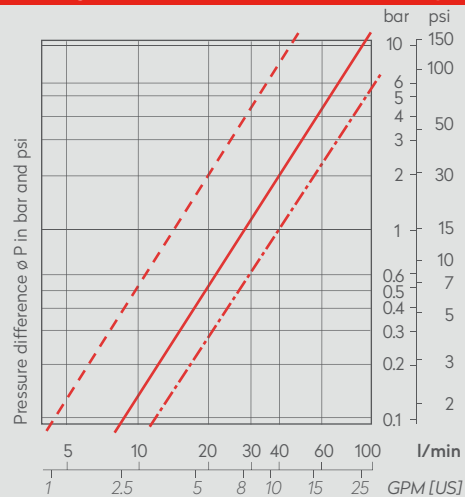

# Performance Graph Stainless Steel

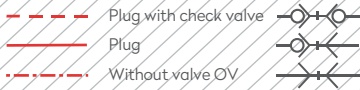

Flow Rate at 68°F (20 °C)  
Operating Pressure 87 psi (6 bar)

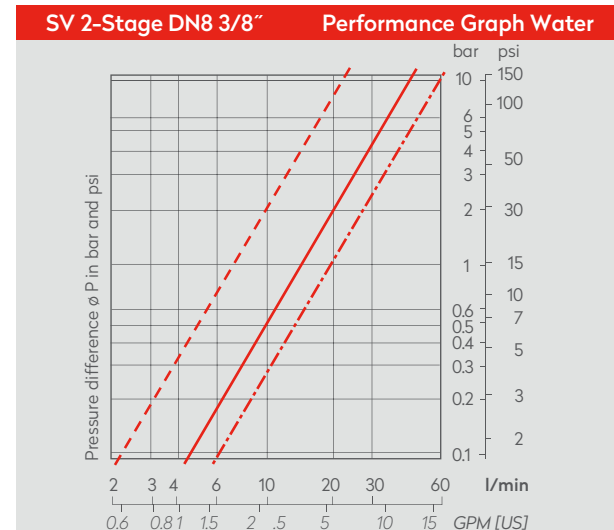
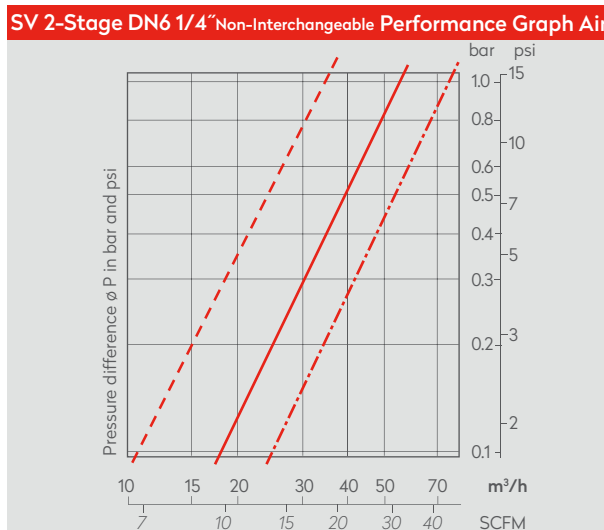
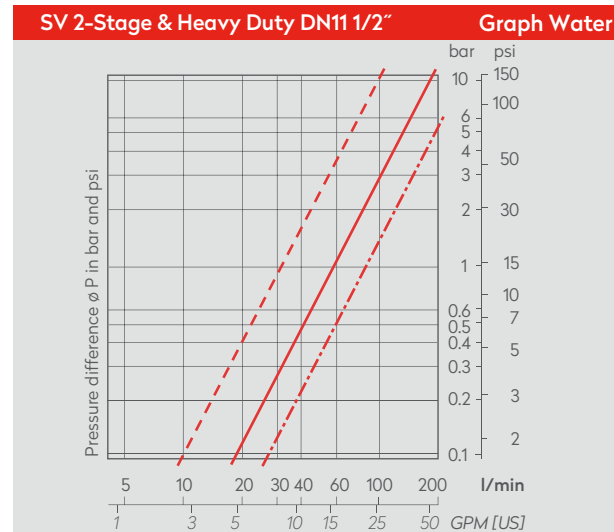
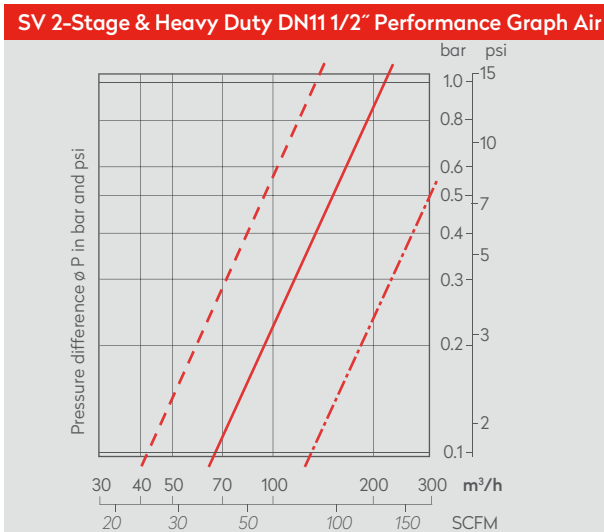
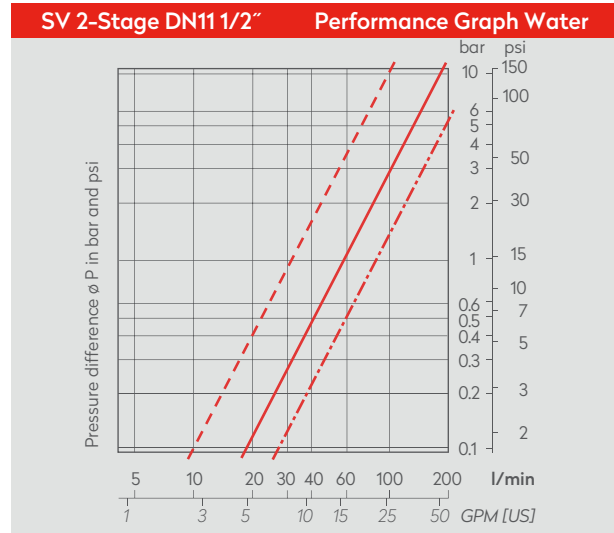
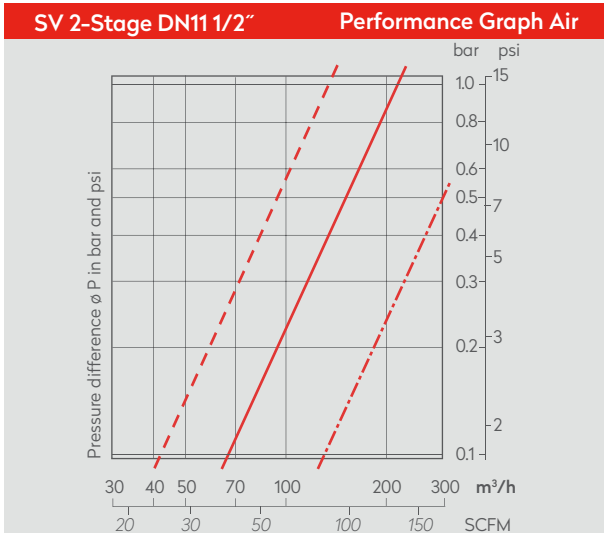

# ICON INDEX

## Icons Related with Application Area



The pressure ranges vary for each product shown in this leaflet. Before ordering, please mention the application pressure to make sure the product meets the system requirements.



Temperature range of our products vary according to the sealing components chosen. Most common sealing types are listed below. For custom requirements, please contact us.



Is the actual diameter which fluid passes through. TST is capable of manufacturing products with nominal diameter of DN 2,7 mm's up to DN 75 mm's.

### FLOW SYMBOLS

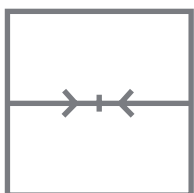

**THROUGH FLOW**  
(Both Sides are Without Valve)

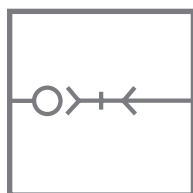

**SINGLE SHUT OFF**  
(One side is With Valve)

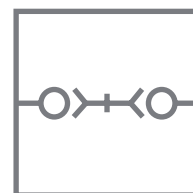

**DOUBLE SHUT OFF**  
(Both Sides are With Valve)

### OTHER ICONS

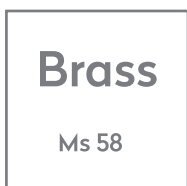

## TAMSAN BAĞLANTI ELEMANLARI A.Ş.

GEPOSB Gebze / Kocaeli TÜRKİYE

Factory Tel: +90 262 751 20 44

Fax: +90 262 751 30 44

info@tst-tamsan.com

### EXPORT DEPARTMENT

Tel: +90 262 751 20 25

Fax: +90 262 751 20 50

sales@tst-tamsan.com

[www.tst-tamsan.com](http://www.tst-tamsan.com)

SWING COUPLING / SV SERIE / STAINLESS STEEL SERIE

The logo for TST is rendered in a bold, red, sans-serif font. The letters 't', 's', and 't' are connected. The first 't' has a grey horizontal bar across its middle. The 's' is a simple, rounded shape. The second 't' has a grey horizontal bar across its middle. A registered trademark symbol (®) is positioned to the upper right of the final 't'.

SMART SOLUTIONS FOR INDUSTRIAL CONNECTIONS