

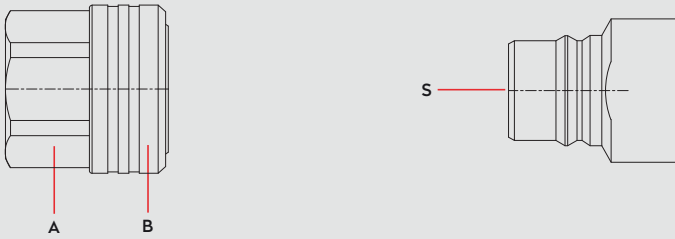

**Materials**



**Material Code**

- A = Brass Chrome Plated
- B = Brass Chrome Plated
- S = AISI 420 / Chrome Plated



0 - 10 bar



-40° to + 105°C (NBR)

**Shut Off Type**



 <p><b>COUPLING</b></p>	<b>TST 106.25</b>	<b>TST 106.38</b>	<b>TST 106.50</b>
	OM 353 - 02975	OM 353 - 03810	OM 534 - 05650

**DN**

- TST 106.25 → 25 mm
- TST 106.33 → 33 mm
- TST 106.50 → 50 mm

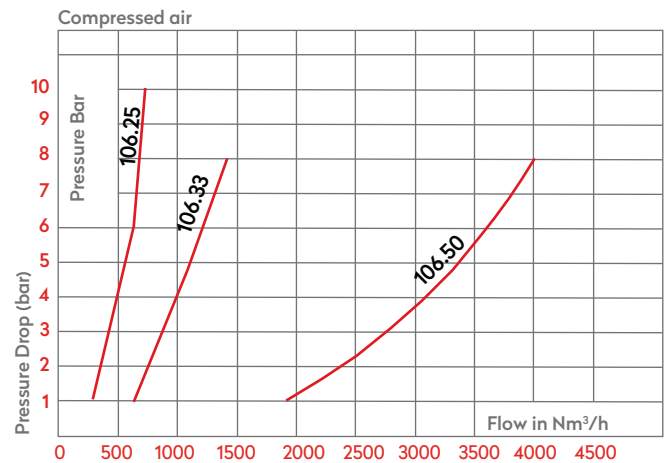
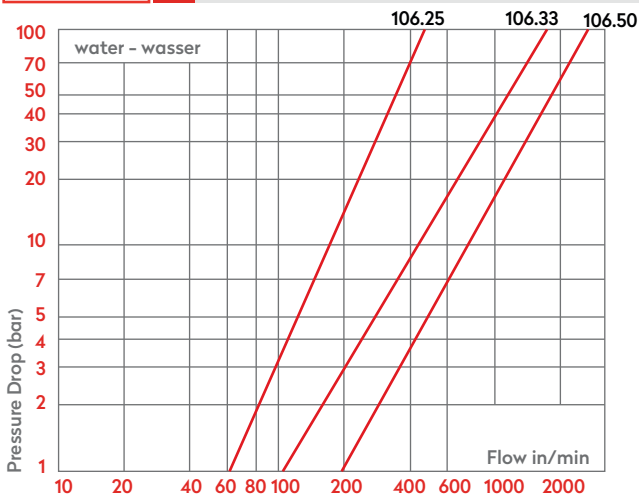

**Options**

- FPM
- EPDM
- AISI316

**Applications**

- Compressed air circuits
- Water connections

**Compatible with**

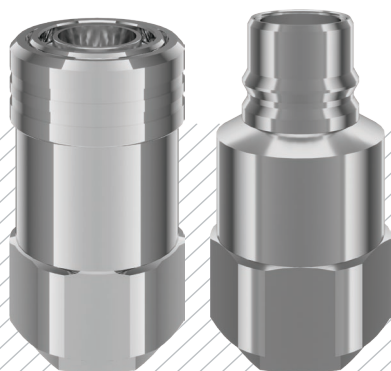
 MOULD COOLING COUPLINGS  
 KÜHLUNGSELEMENTE FÜR WERKZEUGE

## SERIE 106

## QUICK COUPLINGS SCHNELLKUPPLUNGEN

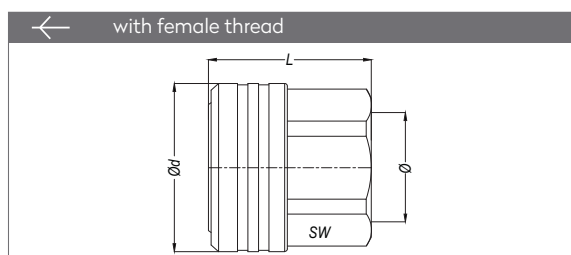

Part No.	DN	Ø	Ød	L	SW
106.25 DGF 33	25	BSP 1"	57	57	46
106.33 DGF 42	33	BSP 1 1/4"	64	62	55
106.50 DGF 60	50	BSP 2"	89	70	77

## VALVED QUICK COUPLINGS SCHNELLKUPPLUNGEN MIT VENTIL

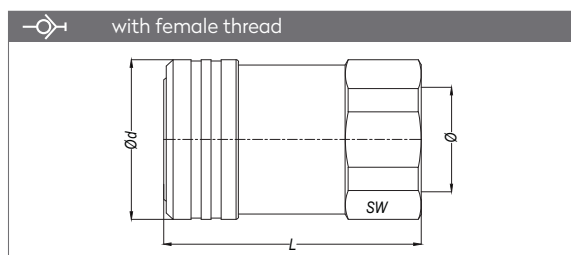

Part No.	DN	Ø	Ød	L	SW
106.33 DGB 33	33	BSP 1"	64	111.3	111.3
106.33 DGB 42	33	BSP 1 1/4"	64	103.3	103.3

## ACCESSORIES ZUBEHÖR

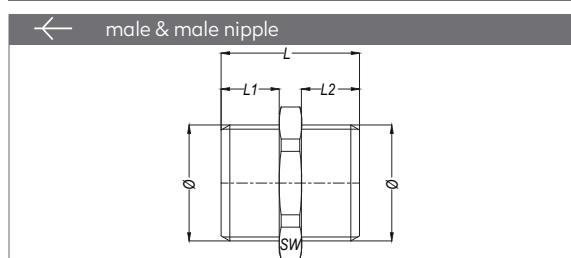

Part No.	DN	Ø	L	L1	L2	SW
EE 33-33K	25	BSP 1"	46	19	19	41
EE 42-42K	33	BSP 1 1/4"	52	21	21	50
EE 60-60K	50	BSP 2"	65	25	25	70

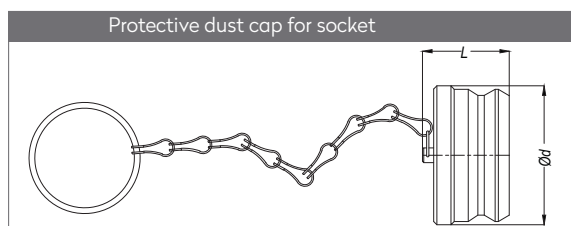

Part No.	DN	Ø	Ød	L
106.25 KG 00	25	BSP 1"	35	26.2
106.33 KG 00	33	BSP 1 1/4"	44	27.2
106.50 KG 00	50	BSP 2"	64	27.2

## PLUGS STECKNIPPEL

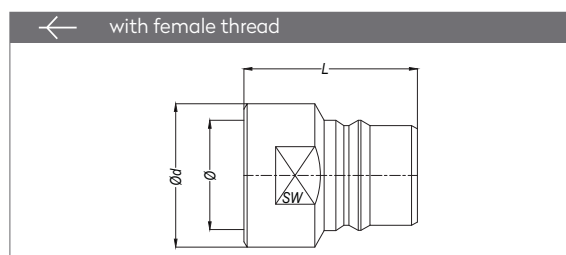

Part No.	DN	Ø	Ød	L	SW
106.25 DU 33	25	BSP 1"	44.6	61	41
106.33 DU 42	33	BSP 1 1/4"	54.6	66	50
106.50 DU 60	50	BSP 2"	74.6	78	71

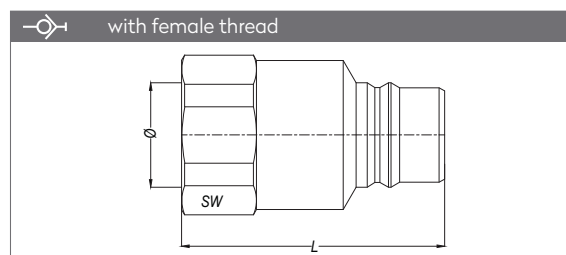

Part No.	DN	Ø	L	SW
106.33 DUB 33	33	BSP 1"	113.5	60
106.33 DUB 42	33	BSP 1 1/4"	105.5	60

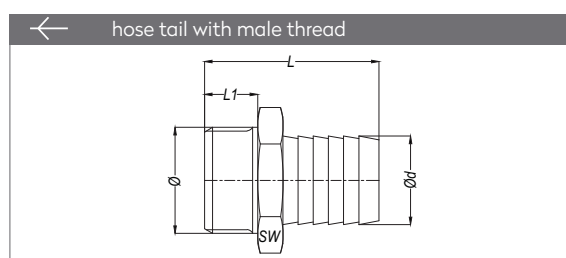

Part No.	DN	Ø	Ød	L	L1	SW
106.25 TAF 25	25	BSP 1"	28	69	21	40
106.25 TAF 33	25	BSP 1"	35	69	21	40
106.33 TAF 32	33	BSP 1 1/4"	35	69	21	50
106.33 TAF 42	33	BSP 1 1/4"	41	69	21	50
106.50 TAF 51	50	BSP 2"	54	85	25	70
106.50 TAF 60	50	BSP 2"	61	85	25	70